

2-Lamp Rapid Start to 2-Lamp Electronic Instant Start

2-Lamp Rapid Start Wiring

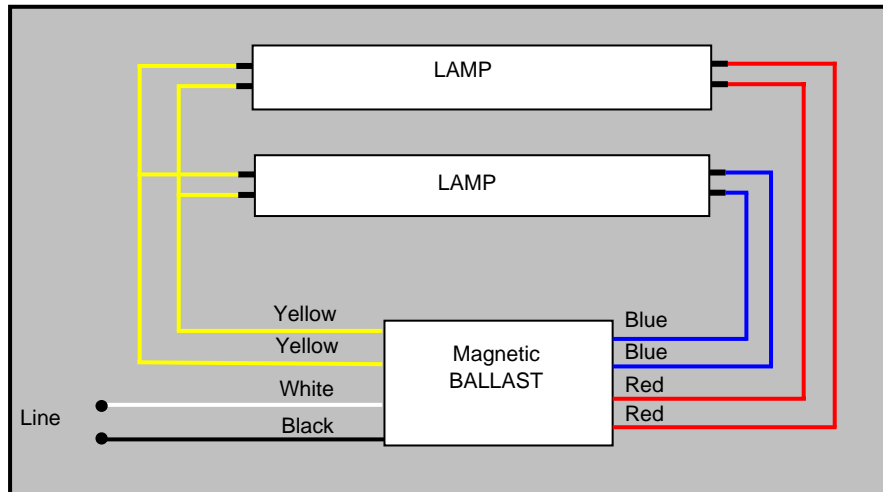

Electronic (Instant Start) Wiring

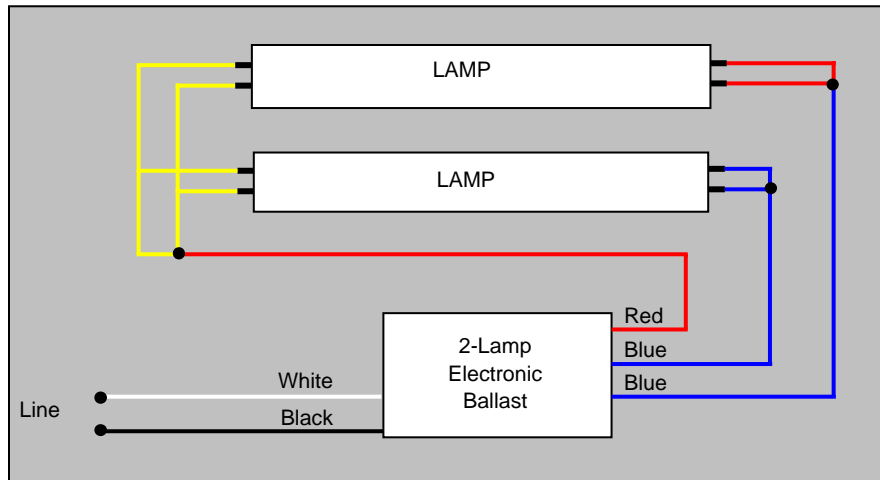

Notes:

- This is applicable for 2-lamp T12 rapid start to a 2-lamp electronic T8 system.
- Disconnect power to lighting fixture prior to servicing the fixture.